

Rev	Description	Rev. by	Date

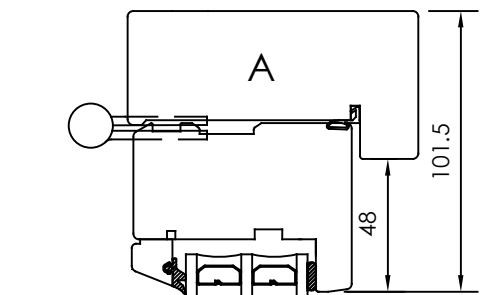

MAIN VERTICAL CROSS SECTION

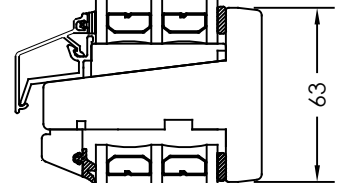

VERTICAL CS OPTION
- Norwegian nose.

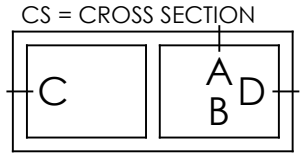
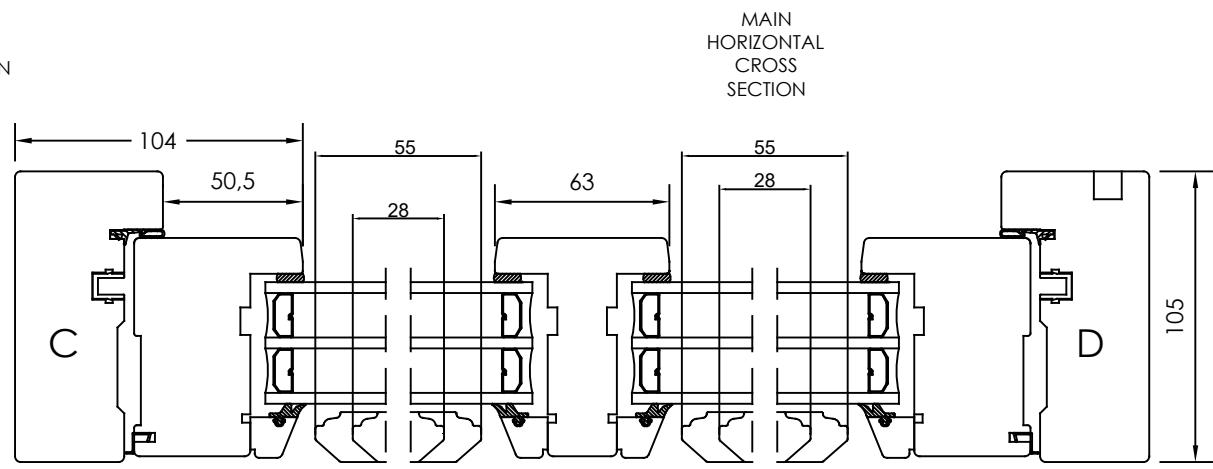
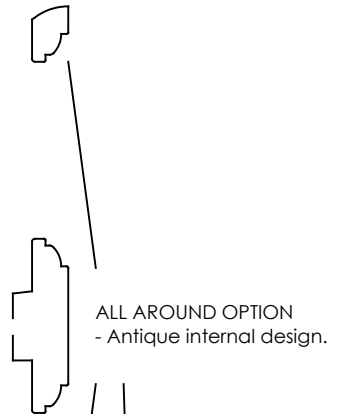
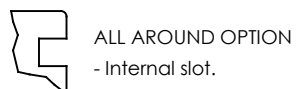
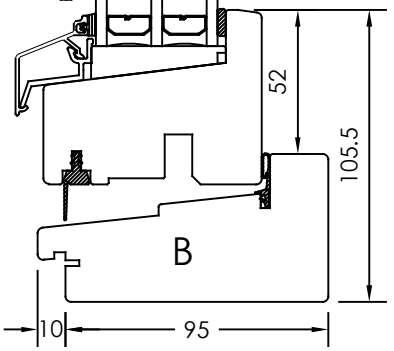
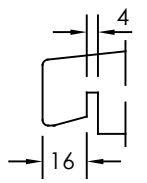

Designed by SH	Designed date 2023-12-07	Product Category Window Outward	Processing Code
Approved by JB	Approved date 2023-12-07	Product Type Top Hung	Material
		Överkantshängt 3-glas, glaslist 44 Top hung 3-glass, glazing bar 44	Tolerances unless otherwise specified ISO 2768-1 m Article Number 61-37-O021
		View orientation 	Scale 1:1
		Revision A	

We reserve all rights in this document and in the information contained therein. Reproduction, use or disclosure to third parties without express authority is strictly forbidden. INWIDO