

VARIANT, FITTINGS

- Exterior hinges.
- Exterior tilt before turn hinges (kipp-dreh).
- Internal hidden tilt before turn hinges (kipp-dreh).

ALL AROUND OPTION

- Internal slot (not for exterior kipp-dreh).

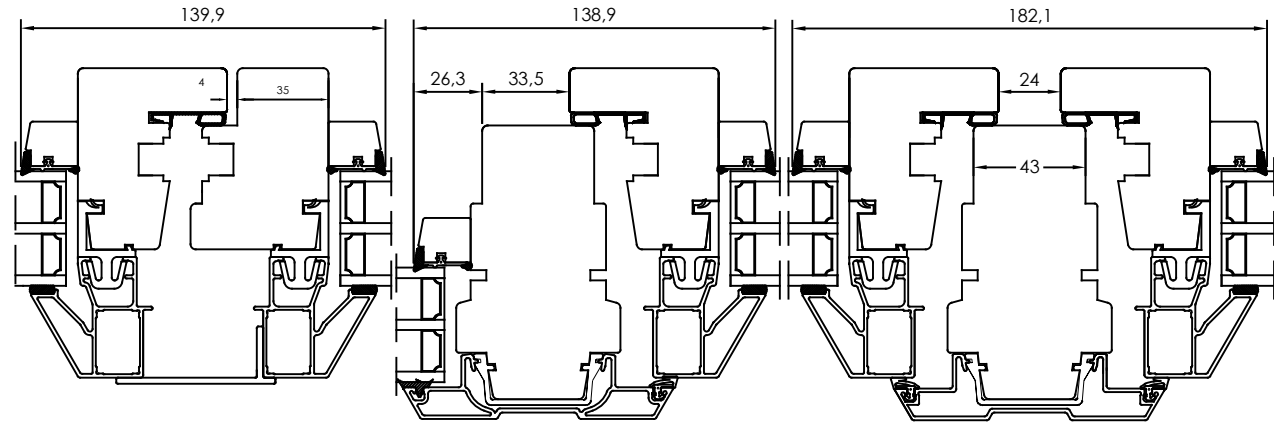

HORIZONTAL CS OPTION

- Two horizontal abutting sashes.

HORIZONTAL CS OPTION

- One glass in fixed frame, the other in sash with side hung fittings and kipp-dreh function.

HORIZONTAL CS OPTION

- Two horizontal sashes with middle post.

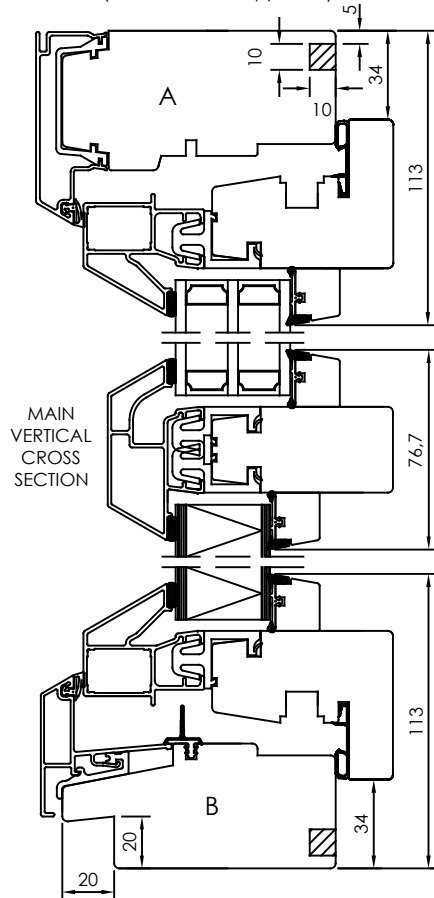

MAIN VERTICAL CROSS SECTION

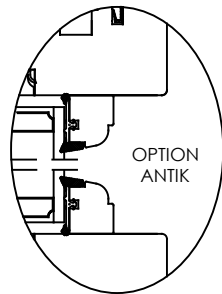

VERTICAL CS OPTION - Norwegian nose.

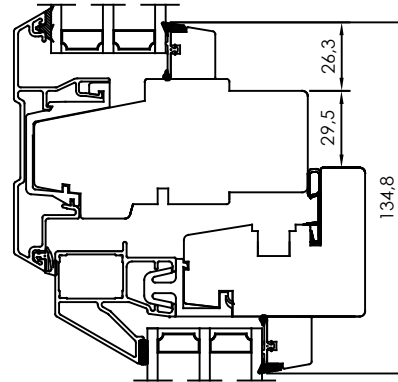
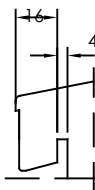

VERTICAL CS OPTION

- Top glass in frame and bottom glass in sash with side hung fittings and kipp-dreh function.

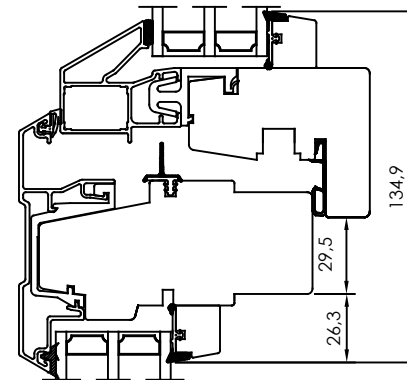

VERTICAL CS OPTION

- Top glass in sash with side hung fittings and kipp-dreh function, bottom glass in frame.

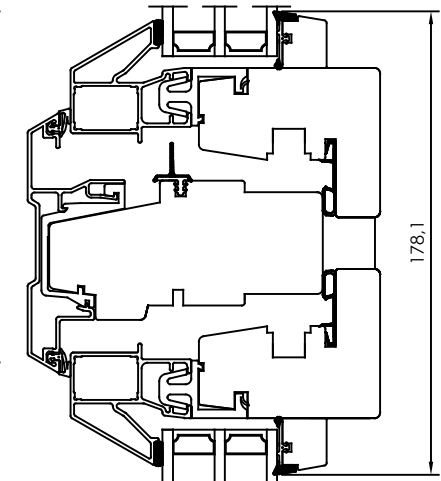

VERTICAL CS OPTION

- Top and bottom glass in sash with side hung fittings and kipp-dreh function, a middle post inbetween.

CS = CROSS SECTION

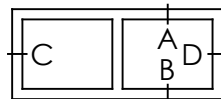

Item	No.	Description	Drawingnumber	Articlenumber
Revision notification		Revised date		
AM40-20161109TE		Revised date		
Revision description		Created by		
Description		Created date		
Window, Inward opening 3-glass.		SH		
Material		General tolerance acc. to ISO2768-1		
ISO 2768-1 m		Processing code		
Included in product		Included in product family		
Inward		Article number		
		Bottom Hung + Side Hung + Tilt & Turn		



Draw view

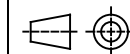

Scale

1:2

Size

A3

Drawing number

40-37-W42 E (A)

Revision no.